

Panoramic Security Surveillance Network Camera User Manual



Issue

V1.0

Date

2019-01-28





Precautions

Precautions

Fully understand this document before using this device, and strictly observe rules in this document when using this device. If you install this device in public places, provide the tip "You have entered the area of electronic surveillance" in an eye-catching place. Failure to correctly use electrical products may cause fire and severe injuries. To prevent accidents, carefully read the following context:

Symbols

This document may contain the following symbols whose meanings are described accordingly.

Symbol	Description
 DANGER	It alerts you to fatal dangers which, if not avoided, may cause deaths or severe injuries.
 WARNING	It alerts you to moderate dangers which, if not avoided, may cause minor or moderate injuries.
 CAUTION	It alerts you to risks. Neglect of these risks may cause device damage, data loss, device performance deterioration, or unpredictable results.
 TIP	It provides a tip that may help you resolve problems or save time.
 NOTE	It provides additional information.



DANGER

To prevent electric shocks or other dangers, keep power plugs dry and clean.



WARNING

- Strictly observe installation requirements when installing the device. The manufacturer shall not be held responsible for device damage caused by users' non-conformance to these requirements.

- Strictly conform to local electrical safety standards and use power adapters that are marked with the LPS standard when installing and using this device. Otherwise, this device may be damaged.
- Use accessories delivered with this device. The voltage must meet input voltage requirements for this device.
- If this device is installed in places with unsteady voltage, ground this device to discharge high energy such as electrical surges in order to prevent the power supply from burning out.
- When this device is in use, ensure that no water or any liquid flows into the device. If water or liquid unexpectedly flows into the device, immediately power off the device and disconnect all cables (such as power cables and network cables) from this device.
- Do not place Panoramic security surveillance network camera and unpackaged products at a radiation source with a high intensity regardless of whether the device is in the normal power-on state, for example, the sun, laser, and electric arc welder, and place Panoramic security surveillance network camera and unpackaged products against objects with a high heat source, for example, the sun. Otherwise, the accuracy of Panoramic security surveillance network camera will be affected. In addition, the detector in Panoramic security surveillance network camera may be permanently damaged.
- If this device is installed in places where thunder and lightning frequently occur, ground the device nearby to discharge high energy such as thunder strikes in order to prevent device damage.



CAUTION

- During the outdoor installation, prevent the morning or evening sunlight incidence to the lens of the camera. The sun shade must be installed and adjusted according to the angle of the sunlight illumination.
- Avoid heavy loads, intensive shakes, and soaking to prevent damages during transportation and storage. The warranty does not cover any device damage that is caused during secondary packaging and transportation after the original packaging is taken apart.
- This device is a static sensitivity device. Improper static may damage the camera. ESD protection measures and reliable grounding must be well prepared for device installation and uninstallation.
- Protect this device from fall-down and intensive strikes, keep the device away from magnetic field interference, and do not install the device in places with shaking surfaces or under shocks.
- Use a soft and dry cloth to clean the device body. In case that the dirt is hard to remove, use a dry cloth dipped in a small amount of mild detergent and gently wipe the device, and then dry it again. Pay special attention to the front window of camera because this is precision optics. If the front window has water spots, use a clean and soft cloth to moisten with water and wipe it. If the front window needs

further cleaning, use a soft cloth dampened with isopropyl alcohol or detergent. Improper cleaning can cause damage to the device.

- Do not jam the ventilation opening. Follow the installation instructions provided in this document when installing the device.
- Keep the device away from heat sources such as radiators, electric heaters, or other heat equipment.
- Keep the device away from moist, dusty, extremely hot or cold places, or places with strong electric radiation.
- If the device is installed outdoors, take insect- and moisture-proof measures to avoid circuit board corrosion that can affect monitoring.
- Remove the power plug if the device is idle for a long time.
- Before unpacking, check whether the fragile sticker is damaged. If the fragile sticker is damaged, contact customer services or sales personnel. The manufacturer shall not be held responsible for any artificial damage of the fragile sticker.

Special Announcement

All complete products sold by the manufacturer are delivered along with nameplates, operation instructions, and accessories after strict inspection. The manufacturer shall not be held responsible for counterfeit products.

This manual may contain misprints, technology information that is not accurate enough, or product function and operation description that is slightly inconsistent with the actual product. The manufacturer will update this manual according to product function enhancement or changes and regularly update the software and hardware described in this manual. Update information will be added to new versions of this manual without prior notice.

This manual is only for reference and does not ensure that the information is totally consistent with the actual product. For consistency, see the actual product.

Contents

1 Product Overview	6
1.1 Description of Product.....	6
1.2 Device Structure.....	6
1.3 Cable Connection	7
2 Installation	9
2.1 Preparations.....	9
2.2 Installation Mode.....	9
2.3 Installation Procedure.....	9
3 Quick Configuration	15
3.1 Login and Logout	15
3.2 Main Page layout.....	16
3.3 Change the Password.....	18
3.4 Browse Video	19
3.4.1 Install Plugins.....	21
3.5 Setting Local Network Parameters	21
4 Parameter Setting.....	24
4.1 Sensor Setting Interface.....	24
4.2 Time Segment.....	25
4.3 Image Setting	25
4.4 Scene	27
4.5 Exposure.....	27
4.6 White Balance	29
4.7 DayNight.....	30
4.8 Noise Reduction	31
4.9 Enhance Image	32
5 Configuration	35
5.1 Device Information	35
5.2 Stream	36
5.3 Device	40
5.4 Intelligent Analysis.....	41

5.5 Alarm.....	41
5.6 Device Record.....	42
5.7 Privacy Masking.....	43
5.8 Network Service.....	44
5.9 Privilege Manager	44
5.10 Protocol	45
5.11 Device Log	46
5.12 Maintenance	46
5.13 Local Config.....	47
6 Technical Specifications.....	48

1 Product Overview

1.1 Description of Product

Panoramic security surveillance network camera provides $360^{\circ} * 360^{\circ}$ panoramic views without blind spots, making it ideal for wide and open areas, such as airport, shopping malls, banks, hotels, stores, square and more. The camera is 8MP single pixel, and 32MP four eyes.

1.2 Device Structure

Figure 1-1 shows the rear panel of the Panoramic Security Surveillance Network Camera. For details about the interfaces, see Table 1-1.

Figure 1-1 Appearance and interfaces of device

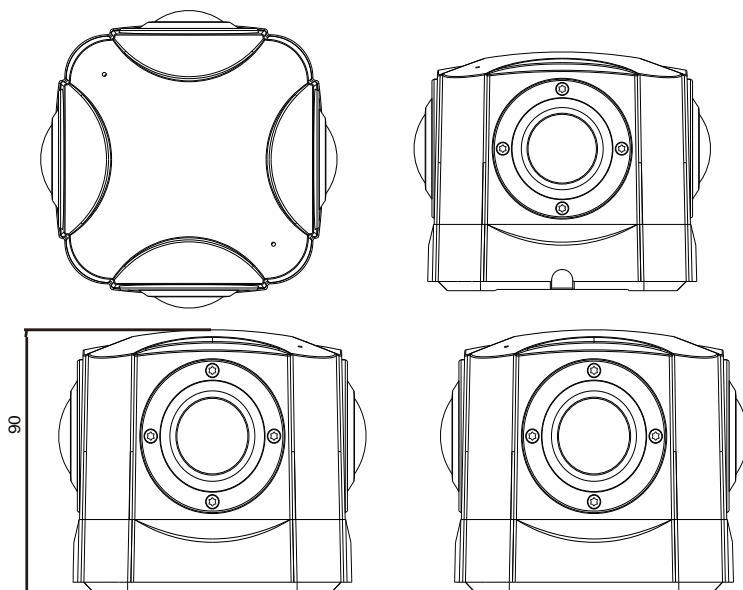

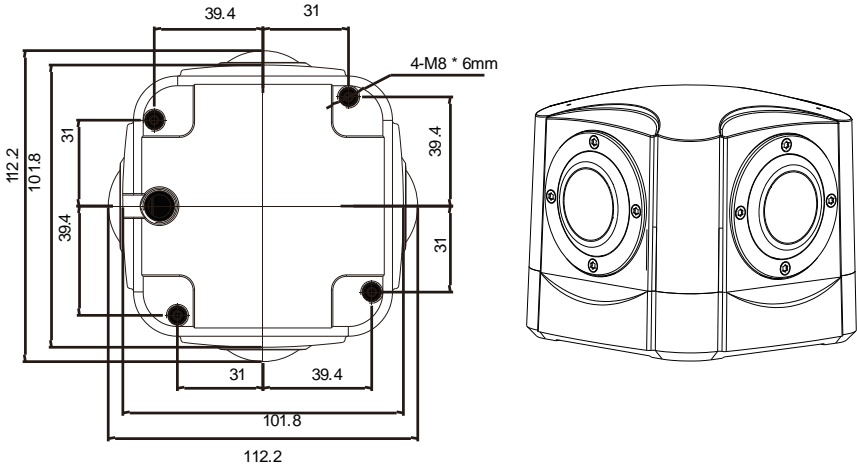

Table 1-1 Interfaces

1.3 Cable Connection

Figure 1-2 the multi-connector combination cable of the network camera. For details about the multi-connector combination cable, see Table 1-2.

Figure 1-2 Multi-connector combination cable

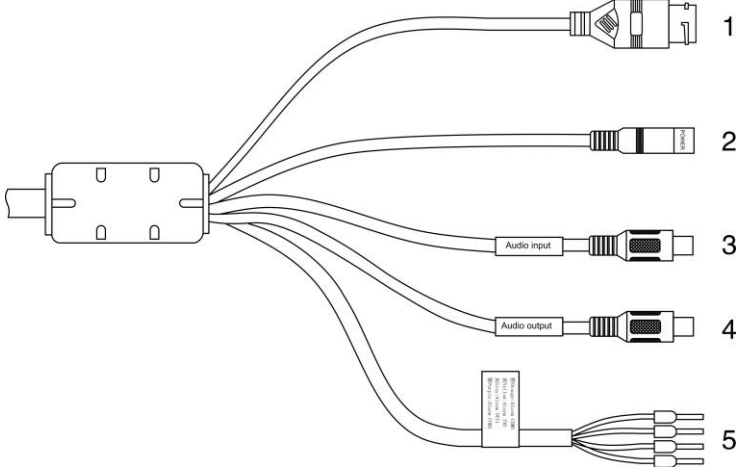

Table 1-2 Multi-connector combination cable

NO.	Color	Port	Description
1	N/A	Network access port	Connects to a standard Ethernet cable.
2		Power supply port	Connects to a 12V direct current (DC) power supply.
3		Audio input port	Receives analog audio signals from devices such as a sound pickup device.
4		Audio output port	Connects to an external audio device such as a speaker.
5	Gray core	Alarm output terminal A (normal open)	Alarm output
	Purple core	Alarm output terminal B (normal open)	
	yellow core	Alarm input positive terminal	Alarm input terminal
	Orange core	Alarm input ground terminal	

1.4 Configuration Requirements

CPU: Intel(R) Core(TM) i7-8700 cpu @3.20GHz or later

RAM:16GB or more



Graphics card: GeForce GTX 1070 Ti or above.

2 Installation

2.1 Preparations

User need the tools and accessories shown in Table 2-1 during the installation (you need to prepare the tools by yourself, and the accessories are in the package of the camera).

Table 2-1 Installation tools

Tools	Appearance
L-Wrench (delivered with the camera)	
Hexagon socket stainless steel screw(delivered with the camera)	

2.2 Installation Mode

If the camera is installed indoor, a bracket should be selected; if the camera is installed outdoor, the shield and upright column should be selected.

 **NOTE**

The bracket where the support is mounted must be able to withstand at least three times of the total weight of the support and the camera.

2.3 Installation Procedure

- Step 1 Remove the installation block delivered with the camera. Fix the installation block on the top or on the bottom of the camera, as shown in Figure 2-1.

Figure 2-1 Fix the installation block

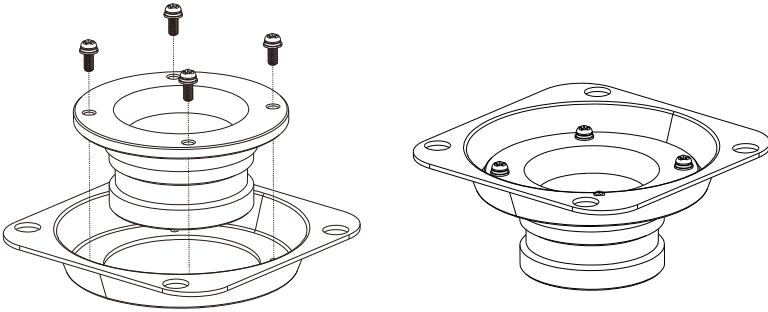
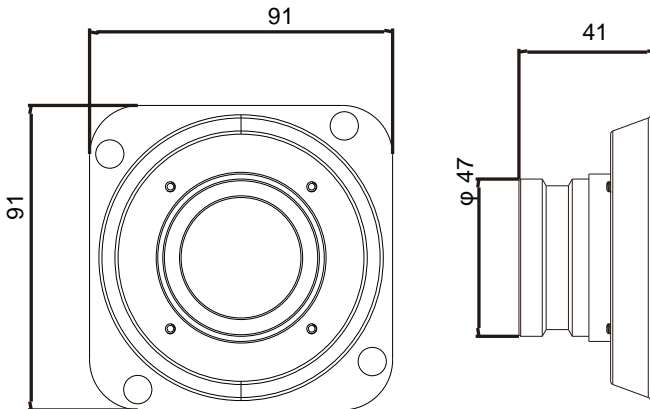
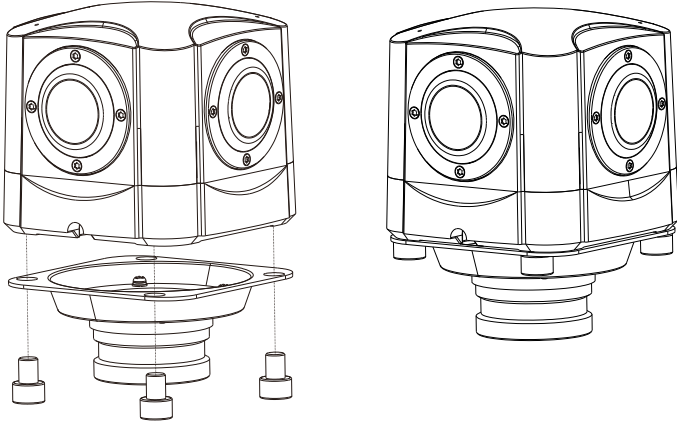

Figure 2-2 Dimension of bracket



Step 2 Fix the mounting bracket on the pole, as shown in Figure 2-3.

Figure 2-3 Fix the mounting bracket



Step 3 (Install with Column) Align the camera adapter with the adapter hole on the column, and when it is in place, fix the two with screws and confirm that fixing screw is fixed in the groove of the adapter, as shown in Figure 2-4.

Figure 2-4 Install with column

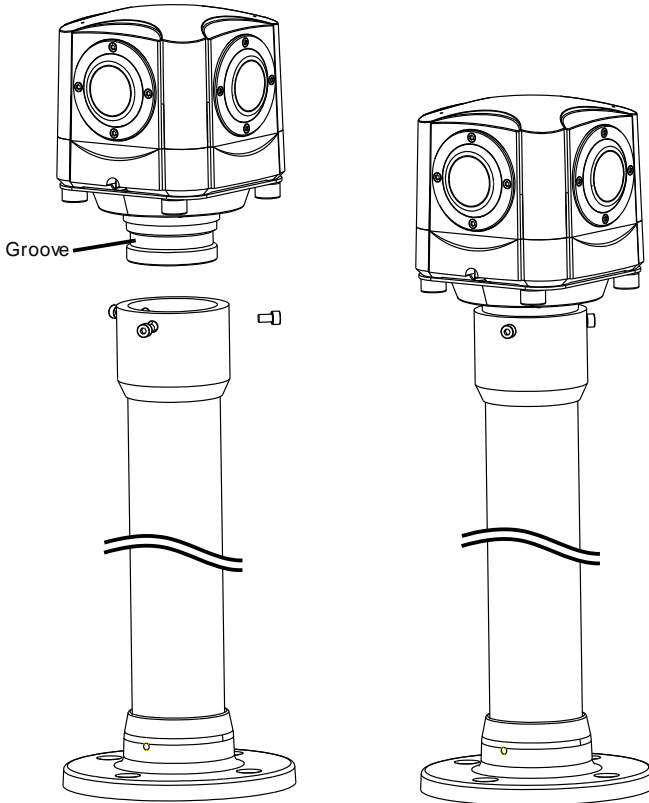

Step 4 (Install on ceiling) Fix the mounting bracket on the pole, as shown in Figure 2-5.

Figure 2-5 Fix the mounting bracket

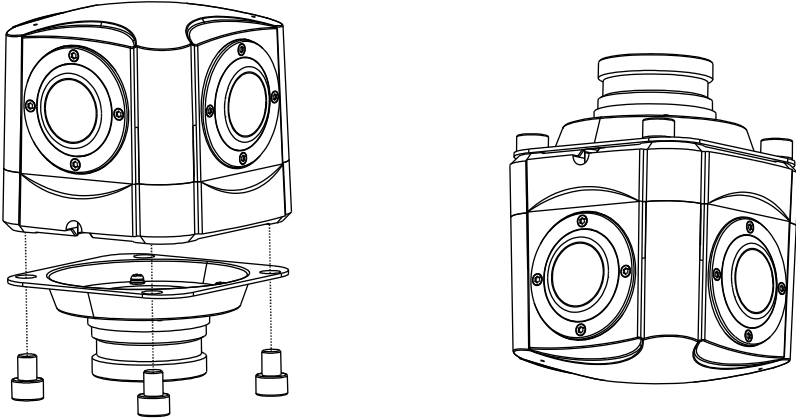

Step 5 (Install on ceiling) Align the camera adapter with the adapter hole on the column, and when it is in place, fix the two with screws and confirm that fixing screw is fixed in the groove of the adapter, as shown in Figure 2-4.

3 Quick Configuration

3.1 Login and Logout



CAUTION

You must use Internet Explorer 8 or a later version to access the web management system; otherwise, some functions may be unavailable.

Login system

Step 1 Open the Internet Explorer, enter the IP address of IP camera (default value: 192.168.0.120) in the address box, and press Enter.

The login page is displayed, as shown in Figure 3-1.

Figure 3-1 Login page

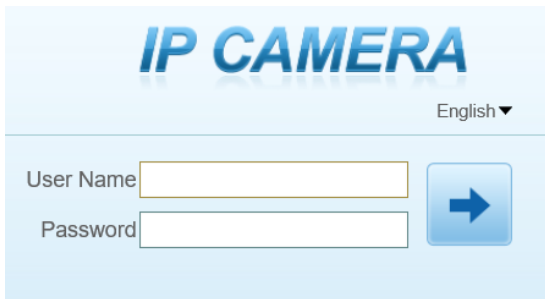

Step 2 Input the User and password.

NOTE

- The default name and password are both **admin**. Modify the password when you login the system for first time to ensure system security. After modifying password, you need to wait at least three minutes then power off to make sure modifying successfully . Or login the Web again to test the new password.
- You can change the system display language on the login page.

Step 3 Click Login button. The main page is displayed.

----End

logout

To logout of system, click  in the upper right corner of the main page, the login page is displayed after you log out of the system.

3.2 Main Page layout







On the main page, you can view real-time video, set parameter, Video parameter, Video control, and logout of the system. Figure 3-2 is shown the main page layout. Table 3-1 lists the elements on the main page layout.

Figure 3-2 Main page layout



Table 3-1 Elements on the main page



No.	Element	Description
1	Real-time video area	Real-time videos are played in this area. User can also set sensor parameters.
2	Playback	User can query the playback videos in this area. NOTE

No.	Element	Description
		Only when the SD card or NAS have videos that user can query the playback videos.
3	Device configuration	You can choose a menu to set device parameters, including the device information, audio and video streams, alarm setting, and privacy mask function.
4	Change password	You can click  to change the password.
5	Sign Out	You can click  to return to the login page.
6	Stream	There are four streams. Choose one type from drop-down list. Stream 4 is SVC stream.
7	Pause/Start	Close live video or play live video.
8	Live/Smooth	Switch image quality.
9	Audio	Open or close audio.
10	Interphone	Open or close interphone.
11	Sensor setting	Click the icon, it will access to sensor setting.
12	Snapshot	Click the icon, it will snapshot.
13	Local record	Click the icon, it will record video and save to local folder.
14	Mode	     : Panoramic mode, fisheye mode, crystal ball mode, prospective mode, planet mode, as shown in figure 3-3 to figure 3-6.
15	Intelligent analysis	Open or close intelligent analysis.

When the live video is full screen, user can use keyboard shortcuts to switch mode, F2 is for panoramic mode, F3 is for prospective mode, F4 is for crystal ball mode, F5 is for fisheye mode, and F6for is planet mode.

The key A is for autorotation (tour), the key S is for stopping spinning.

 **NOTE**

1. When the device generates an alarm, the alarm icon  is displayed. You can click  to view the alarm information. When the device accepts an alarm signal, the alarm icon will display within 10s in the web management system.



2. When the device encounters an exception, the fault icon  is displayed. You can click  to view the fault information.

Figure 3-3 Prospective mode



Figure 3-4 Crystal ball mode



Figure 3-5 Fisheye mode



Figure 3-6 Planet mode

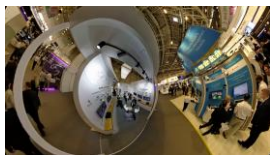

----End

3.3 Change the Password

Description

User can click  to change the password for logging to the system.

Procedure

Step 1 Click  in the upper right corner of the main page.

The **Change Password** dialog box is displayed, as shown in Figure 3-7.

Figure 3-7 Modify Password dialog box

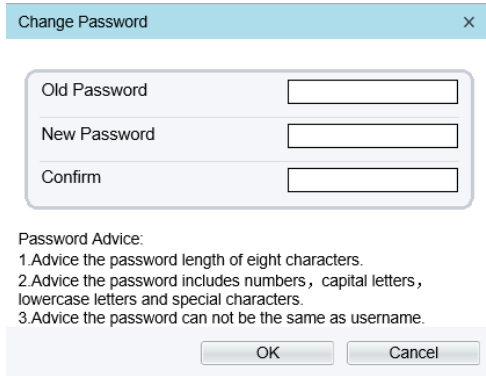

 **NOTE**

The change password page will be displayed if you don't change the default password when you login the system for the first time. User need to wait at least three minutes after changing password, and then restart the device. The password incorrect more than 3 times, please login again after 5 minutes

Step 2 Input the old password, new password, and confirmation password.

Step 3 Click **OK**.

If the message "Change own password success" is displayed, the password is successfully changed. If the password fails to be changed, the cause is displayed. (For example, the new password length couldn't be less than eight.)

Step 4 Click **OK**. The login page is displayed.

----End

3.4 Browse Video

User can browse the real-time video in the web management system.

Preparation

To ensure the real-time video can be play properly, you must perform the following operation when you login to the web for the first time:

Step 1 Open the Internet Explorer. **Choose Tools > Internet options > Security > Trusted sites > Sites.**

In the display dialog box, click **Add**, as shown in Figure 3-8.

Figure 3-8 Add the a trusted site

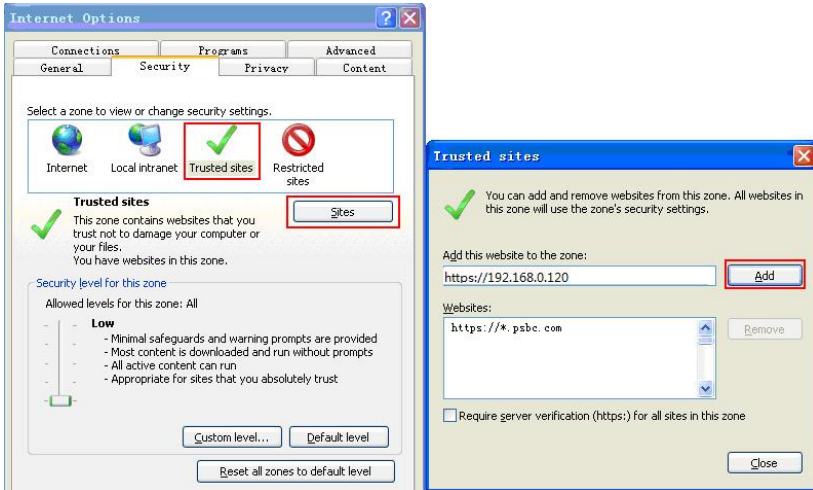

Step 2 In the Internet Explorer, choose **Tool > Internet Options > Security > Customer level**, and set **Download unsigned ActiveX control and initialize and script ActiveX controls not marked as safe for scripting under ActiveX controls and plug-ins** to **Enable**, as shown in Figure 3-9.

Figure 3-9 Configuring ActiveX control and plug-ins

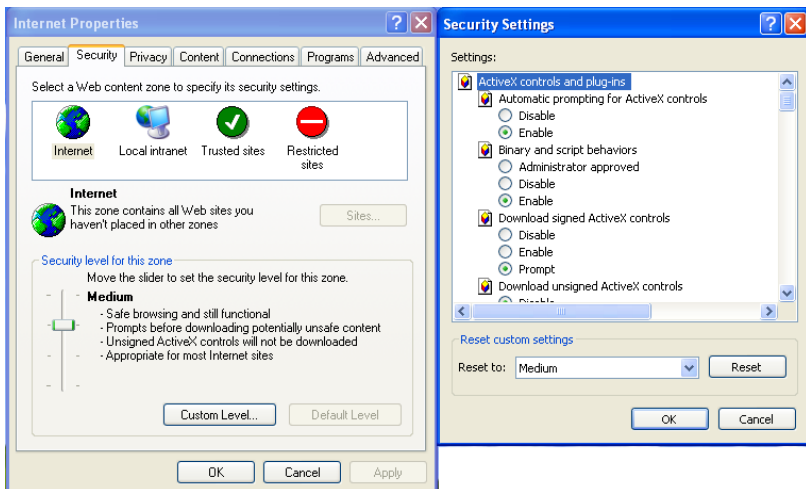

Step 3 Download and install the player control as prompted.

 **NOTE**

The login page is display when the control is loaded.

3.4.1 Install Plugins

You will be prompted with a message “Download and install the new plugin” will show as in Figure 3-10, when you login to the web management system for the first time.

Figure 3-10 Install plugin

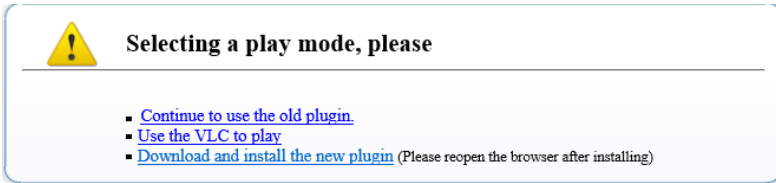

Procedure

Step 1 Click the message, download and install the plugin follow the prompts.

Step 2 During installing, user should close the browser.

Step 3 Reopen the browser after installation.

----End

3.5 Setting Local Network Parameters

Description

Local network parameters include:

- IP protocol
- IP address
- Subnet mask
- Default gateway
- Dynamic Host Configuration Protocol (DHCP)
- Preferred Domain Name System (DNS) server
- Alternate DNS server
- MTU

Procedure

Step 1 Choose **Configuration > Device >Local Network.**

The **Local Network** page is displayed, as shown in Figure 3-11.

Figure 3-11 Local Network page

Local Network

Network Card ID: 1

IP Protocol: IPv4

DHCP: OFF

IP Address: 192.168.0.120

Subnet Mask: 255.255.255.0

Default Gateway: 192.168.32.254

Preferred DNS Server: 192.168.0.1

Alternate DNS Server: 192.168.0.2

MTU(800-1500): 1500

Refresh Apply

Step 2 Set the parameters according to Table 3-2.

Table 3-2 Local network parameters

Parameter	Description	Setting
IP Protocol	IPv 4 is the IP protocol that uses an address length of 32 bits. IPv 6 is the IP protocol that uses an address length of 128 bits.	[Setting method] Select a value from the drop-down list box. [Default value] IPv4
DHCP	The device automatically obtains the IP address from the DHCP server.	[Setting method] Click the option button. NOTE To query the current IP address of the device, you must query it on the platform based on the device name.
DHCP IP	IP address that the DHCP server assigned to the device.	DHCP function is enabled.
IP Address	Device IP address that can be set as required.	[Setting method] Enter a value manually. [Default value] 192.168.0.120

Parameter	Description	Setting
Subnet Mask	Subnet mask of the network adapter.	[Setting method] Enter a value manually. [Default value] 255.255.255.0
Default Gateway	This parameter must be set if the client accesses the device through a gateway.	[Setting method] Enter a value manually. [Default value] 192.168.0.1
Preferred DNS Server	IP address of a DNS server.	[Setting method] Enter a value manually. [Default value] 192.168.0.1
Alternate DNS Server	IP address of a domain server. If the preferred DNS server is faulty, the device uses the alternate DNS server to resolve domain names.	[Setting method] Enter a value manually. [Default value] 192.168.0.2
MTU	Set the maximum value of network transmission data packets.	[Setting method] Enter a value manually. NOTE The MTU value is range from 800 to 1500, the default value is 1500, Please do not change it arbitrarily.

Step 3 Click **OK**.

- If the message "Apply success" is displayed, click **OK**. The system saves the settings. The message "Set network param's success, Please login system again" is displayed. Use the new IP address to log in to the web management system.
- If the message "Invalid IP Address", "Invalid Subnet Mask", "Invalid default gateway", "Invalid primary DNS", or "Invalid space DNS" is displayed, set the parameters correctly.

 **NOTE**

- If you set only the **Subnet Mask**, **Default Gateway**, **Preferred DNS Server**, and **Alternate DNS Server** parameters, you do not need to login to the system again.
- You can click **Reset** to set the parameters again if required.

----End

4 Parameter Setting

4.1 Sensor Setting Interface

Operation Procedure

Step 1 On the Internet Explorer interface or the client software interface, select and right-click the surveillance image to the set, as shown in Figure 4-1.

Figure 4-1 Sensor Setting

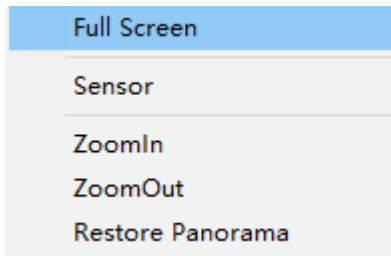

Table 4-1 Right-click setting parameters

Parameter	Description	Setting
Full screen	Click it, the live video will display in full screen	[Setting method] Click
Sensor	Set parameters of sensor, more details please refer next chapters.	[Setting method] Click
Zoom In/ Zoom Out	N/A	[Setting method] Click
Restore Panorama	When the live video is zoom in or out, click the icon to restore.	[Setting method] Click

Step 2 Choose **Sensor**. The **Sensor Configuration** dialog box is displayed, as shown in Figure 4-2.

----End

4.2 Time Segment

Figure 4-2 shows the time segment interface.

Figure 4-2 Time segment interface

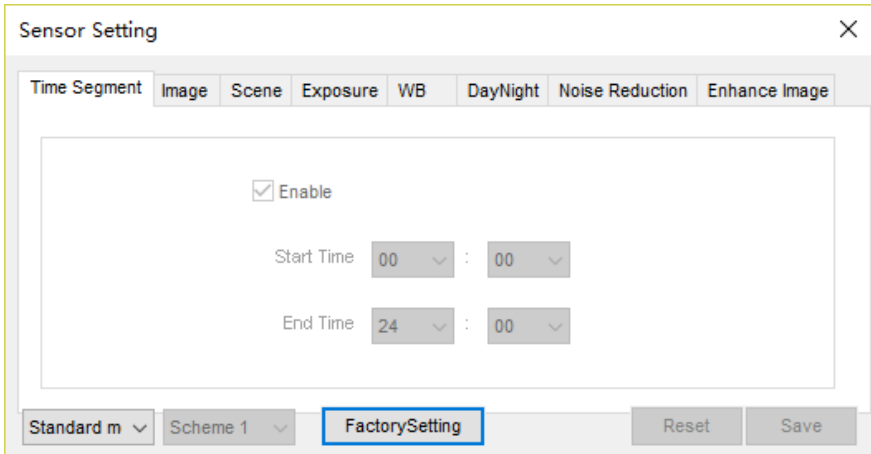

Operation Procedure

- Step 1 Click **Standard** in the lower left corner of Sensor Setting, and choose **Debug Mode**.
- Step 2 Tick **Enable**.
- Step 3 Set the **Start Time**
- Step 4 Set the **End Time**
- Step 5 Click **Save**, the message "Save success" is displayed, the system saves the settings.
----End

4.3 Image Setting

Figure 4-3 shows the image setting interface.

Figure 4-3 Image interface

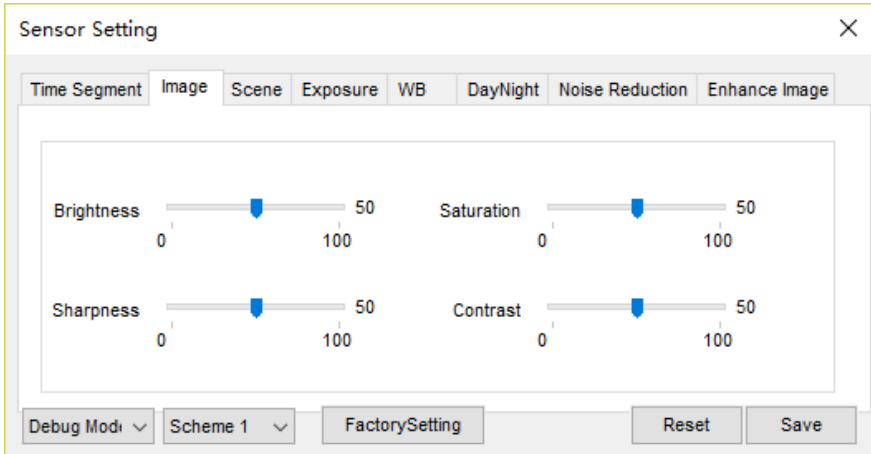

Table 4-2 lists the image setting parameters.

Table 4-2 Image setting parameters

Parameter	Description	Setting
Brightness	It indicates the total brightness of an image. As the value increases, the image becomes brighter.	[Setting method] Drag the slider. [Default value] 50
Sharpness	It indicates the sharpness of the image plane and the sharpness of the image edge. The shaper the image, the better detail contrast.	[Setting method] Drag the slider. [Default value] 50
Saturation	It indicates the color will be more gorgeous if the value is higher.	[Setting method] Drag the slider. [Default value] 50
Contrast	It indicates the contrast between the bright part and the dark part of an image. As the value increases, the contrast increases.	[Setting method] Drag the slider. [Default value] 50

----End

4.4 Scene

Figure 4-4 shows the scene interface.

Figure 4-4 Scene interface

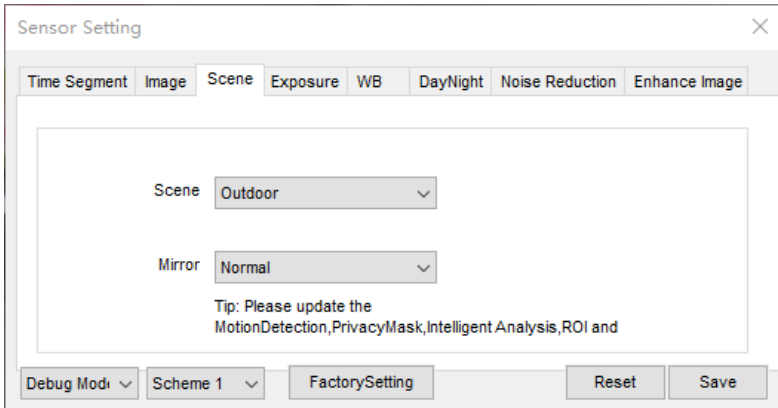

Scene: Indoor and Outdoor.

Mirror: Normal and Rotation

4.5 Exposure

Figure 4-5 shows the exposure interface.

Figure 4-5 Exposure interface

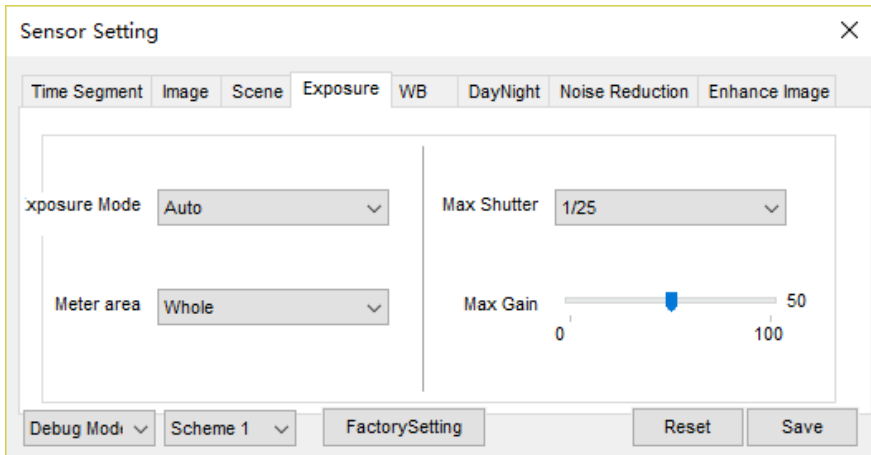

Table 4-3 Exposure parameters description

Parameter	Meaning	Configuration Method
Exposure Mode	<p>The exposure modes include:</p> <ul style="list-style-type: none"> • Auto: The system performs auto exposure based on the monitoring environment. • Manual: You can adjust the brightness of an image by setting the following three items: Shutter Setting, Iris Setting and Gain Setting. • Shutter Priority: You can set Shutter Setting to fixed values. The iris and gain are automatically adjusted by the system. 	<p>[Setting method] Select a value from the drop-down list. [Default value] Auto</p>
Meter area	<p>It is used to select the metering area.</p> <ul style="list-style-type: none"> • Whole: During metering, all areas of an image have an equal weight, that is, all areas are involved in the metering. • Center pot: During metering, the central pot of an image has the highest weight. • Center Area: During metering, the middle area (1/2 of the total area) of an image has the highest weight, and other areas have the lowest weight. 	<p>[Setting method] Select a value from the drop-down list. [Default value] Whole</p>

Max Shutter	The device automatically adjusts the shutter time based on the ambient brightness. The shutter time is less than or equal to the value of this parameter.	[Setting method] Select a value from the drop-down list. [Default value] 1/25
Max Gain	The device automatically adjusts the gain based on the external light. The gain is less than or equal to the value of this parameter.	[Setting method] Drag the slider. [Default value] 50

4.6 White Balance

Figure 4-6 shows the white balance interface.

Figure 4-6 White balance interface

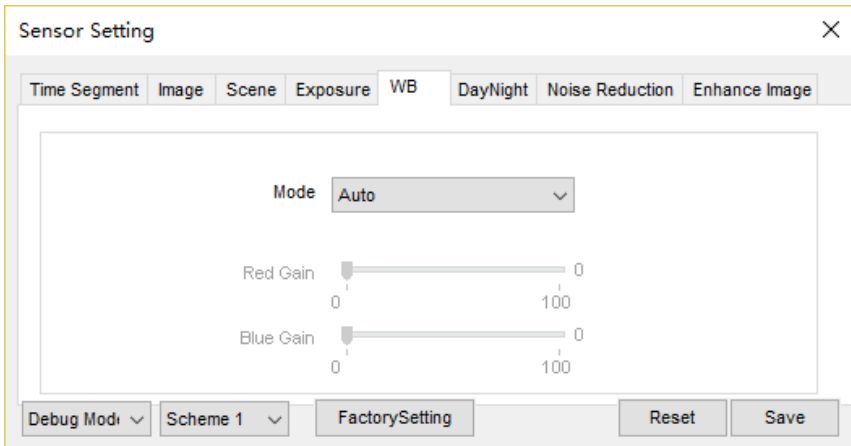



Table 4-4 White balance parameters description

Parameter	Meaning	Configuration Method
Mode	<p>It is adjusted based on application scenarios to improve the fidelity of the image color.</p> <p>The WB modes include:</p> <ul style="list-style-type: none"> • Auto: In automatic white balance (WB) mode, the system automatically performs white balance based on the monitoring environment. • Tungsten • Fluorescent • Daylight • Shadow • Manual: In manual WB mode, you can manually select a WB mode based on the monitoring environment. 	<p>[Setting method] Select a value from the drop-down list. [Default value] Auto</p>
Red Gain	<p>It indicates the gain applied to red channels. As the value increases, the color temperature becomes lower.</p> <p> NOTE This parameter is valid when Manual Mode is set to Customized.</p>	<p>[Setting method] Drag the slider. [Default value] 0</p>
Blue Gain	<p>It indicates the gain applied to blue channels. As the value increases, the color temperature becomes higher.</p> <p> NOTE This parameter is valid when Manual Mode is set to Customized.</p>	<p>[Setting method] Drag the slider. [Default value] 0</p>

4.7 DayNight

Figure 4-7 shows the DayNight interface.

Figure 4-7 DayNight interface

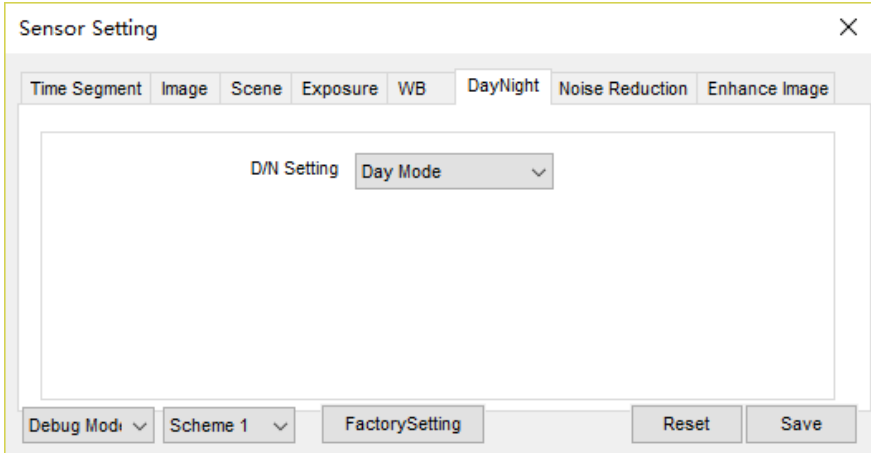

Table 4-5 DayNight parameters description

Parameter	Meaning	Configuration Method
D/N Setting Mode	<p>It can be only set to Day Mode,</p> <ul style="list-style-type: none">Day mode <p>The image is colored, and the filter is in the day state, preventing infrared light from entering the sensor.</p>	<p>[Default value] Day Mode</p>

4.8 Noise Reduction

Figure 4-8 shows the Noise reduction interface.

Figure 4-8 Noise reduction interface

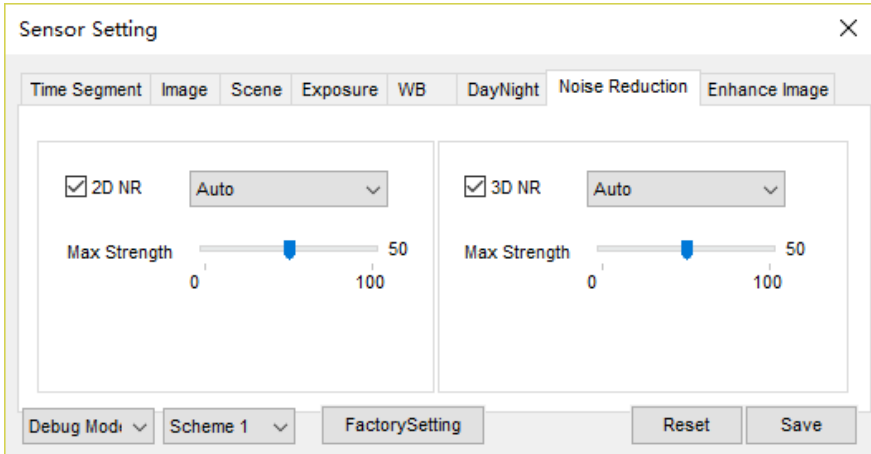

Table 4-6 lists the Noise reduction parameters.

Table 4-6 Parameters on the Noise reduction interface

Parameter	Description	Setting
2 DNR	Decrease the image noise.	[How to set] Select from the drop-down list box. Drag the slider to adjust max strength. [Default value] Auto
3 DNR	Decrease the image noise.	[How to set] Select from the drop-down list box. Drag the slider to adjust max strength. [Default value] Auto

----End

4.9 Enhance Image

Figure 4-9 shows the **Enhance Image** interface.

Figure 4-9 Enhance image interface

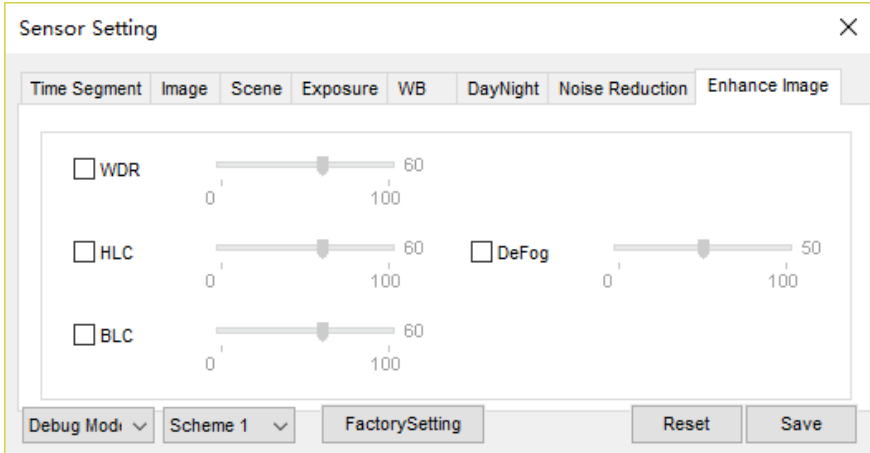

Table 4-7 Enhance image parameters description

Parameter	Meaning	Configuration Method
WDR	It is used to display the foreground and background at the same time in the environment with a large brightness difference. When the brightness difference is larger, you can increase the WDR level to obtain better image effect.	[Setting method] Tick the WDR mode and drag the slider. [Default value] 50
HLC	It provides a clearer view of an image in the highlight environment. When HLC is enabled, the total brightness of an image is reduced, allowing you to view objects in front of the highlight.	[Setting method] Tick the HLC mode and drag the slider. [Default value] 50
BLC	It provides a clearer view of an image in the backlight environment. When BLC is enabled, the total brightness of an image increases, allowing you to view objects in front of the backlight. Meanwhile, the objects behind the backlight are exposed excessively.	[Setting method] Tick the BLC mode.

DeFog	It provides a clearer view of an image in the fogged environment when Defog is enabled. As the value increases, the image becomes clearer.	[Setting method] Tick the Defog mode and drag the slider. [Default value] 50
--------------	---	--

----End

5 Configuration

5.1 Device Information

User can set device name and view the information of camera on Device info interface.

Figure 5-1 Device information interface

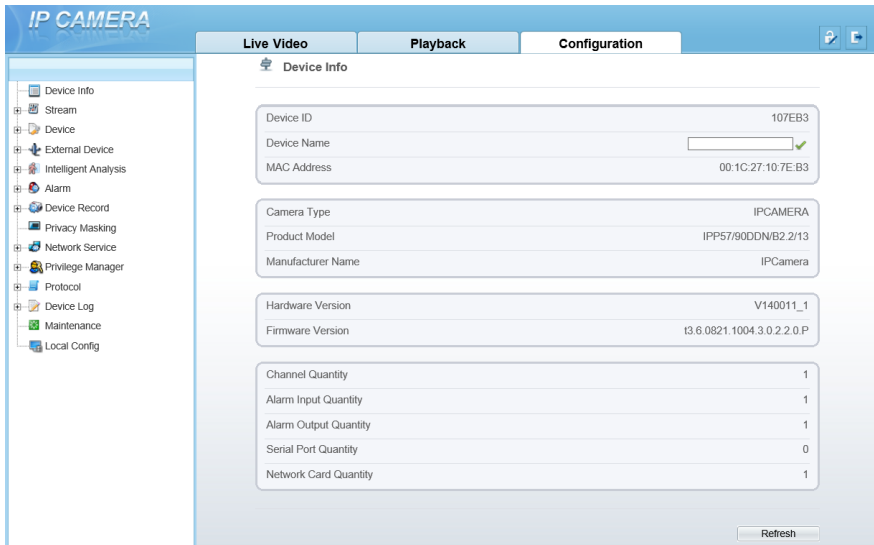

Table 5-1 Device information

Parameter	Description	Setting
Device ID	Unique device identifier used by the platform to distinguish the devices.	[Setting method] The parameter cannot be modified.

Device Name	Name of the device. NOTE The device name cannot exceed 32 bytes or 10 simplified characters; otherwise, the modification fails.	[Setting method] Enter a value manually.
MAC Address	N/A	[Setting method] These parameters cannot be modified.
Camera Type		
Product Model		
Manufacturer Name		
Hardware Version		
Firmware Version		
Video Channel(s)		
Channel Quantity		
Alarm Input Quantity		
Alarm Output Quantity		
Serial Port Quantity		
Network card Quantity		

5.2 Stream

At stream interface, users can set **Base Stream**, **SVC stream** and **ROI**, as shown in Figure 5-2.

Figure 5-2 Stream interface

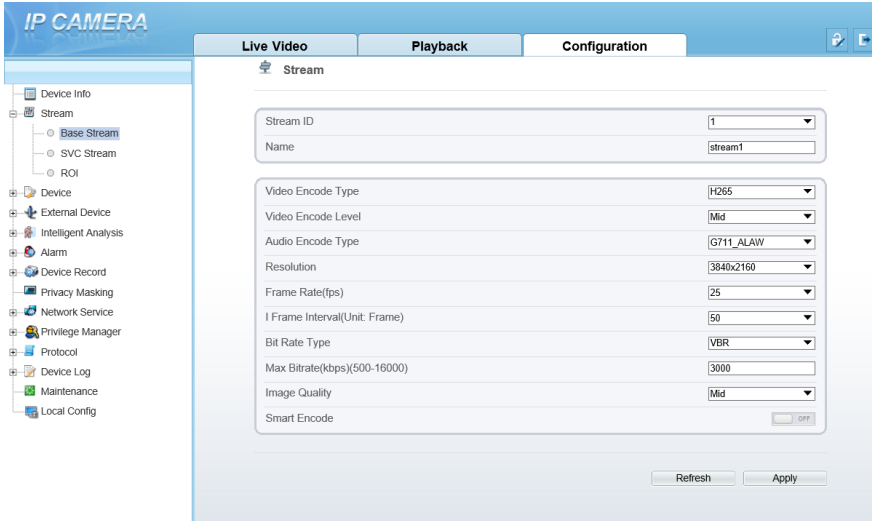

Table 5-2 Stream parameters description

Parameter	Description	Setting
Stream ID	The device supports two streams. <ul style="list-style-type: none"> Streams 1 and 2 use the H.264 codec. The maximum resolution can be set for streams 1. Only a low resolution can be set for stream 2. 	[Setting method] Select a value from the drop-down list box.
Name	Stream name. NOTE The stream name is combined with Chinese character, number, character and underline.	[Setting method] Enter a value manually. The value cannot exceed 32 bytes. [Default value] stream1

<p>Video Encode Type</p>	<p>The video codec determines the image quality and network bandwidth required by a video. Currently, the following codec standards are supported:</p> <ul style="list-style-type: none"> • MJPEG <p>MJPEG is a standard intra-frame compression codec. The compressed image quality is good. No mosaic is displayed on motion images. MJPEG does not support proportional compression and requires large storage space. Recording and network transmission occupy large hard disk space and bandwidth. MJPEG is not applicable to continuous recording for a long period of time or network transmission of videos. It can be used to send alarm images.</p> <ul style="list-style-type: none"> • H.264 <p>H.264 consists of H.264 Base Profile, H.264 Main Profile, and H.264 High profile. The performance of H.264 High Profile is higher than that of H.264 Main Profile, and the performance of H.264 Main Profile is higher than that of H.264 Base Profile. If a hardware decoding device is used, select the appropriate codec based on the decoding performance of the device.</p> <p>H.264 High Profile has the highest requirements on the hardware performance, and H.264 Base Profile has the lowest requirements on the hardware performance.</p> <ul style="list-style-type: none"> • H.265 <p>H.265 is the new video encoding standard ,it's the improvement standard from H.264. H.265 improves the streams, encoding quality and algorithm complexity to make configuration as optimization.</p>	<p>[Setting method] Select a value from the drop-down list box.</p> <p>[Default value] H.264 High Profile</p> <p>NOTE The H.264 High Profile codec means high requirements on the hardware. If the hard decoding capability is low, use H.264 Main Profile or H.264 Base Profile.</p>
<p>Video Encode</p>	<p>Video coding level is the level of the algorithm's performance requirements for decoding hardware devices.</p> <p>H.264</p> <p>Low: H264 Base profile</p> <p>Mid: H264 Main Profile</p> <p>High: H264 High Profile</p> <p>H.265: Mid</p>	

Audio Encode Type	<p>The following audio codec standards are supported:</p> <ul style="list-style-type: none"> • G711_ULAW: mainly used in North America and Japan. • G711_ALAW: mainly used in Europe and other areas. • RAW_PCM: codec of the original audio data. This codec is often used for platform data. 	<p>[Setting method] Select a value from the drop-down list box.</p>
Resolution	<p>A higher resolution means better image quality.</p> <p>NOTE IP cameras support the different resolutions based on the model.</p>	<p>[Setting method] Select a value from the drop-down list box.</p>
Frame Rate(fps)	<p>The frame rate is used to measure displayed frames. A higher frame rate means smoother videos. A video whose frame rate is higher than 22.5 f/s is considered as smooth by human eyes.</p> <p>Frame rates for different frequencies are as follows:</p> <ul style="list-style-type: none"> • 50 Hz: 1–25 f/s • 60 Hz: 1–30 f/s <p>NOTE The frequency is set on the Device Configuration > Camera page. The biggest MJPEG coding format frame rate is 12 frames per second.</p>	<p>[Setting method] Select a value from the drop-down list</p>
I Frame Interval(Frame)	<p>I frames do not require other frames to decode.</p> <p>A smaller I frame interval means better video quality but higher bandwidth.</p>	<p>[Setting method] Select a value from the drop-down list</p>
Bit Rate Type	<p>The bit rate is the number of bits transmitted per unit of time.</p> <p>The following bit rate types are supported:</p> <ul style="list-style-type: none"> • Constant bit rate (CBR) <p>The compression speed is fast; however, improper bit rate may cause vague motion images.</p> <ul style="list-style-type: none"> • Variable bit rate (VBR) <p>The bit rate changes according to the image complexity. The encoding efficiency is high and the definition of motion images can be ensured.</p>	<p>[Setting method] Select a value from the drop-down list box.</p>
Max bit Rate(500-16000)	<p>Indicates the maximal value of the bit rate.</p>	<p>[Setting method] Enter a value manually.</p>

Image Quality	The video quality the camera output.	[Setting method] Select a value from the drop-down list box.
Smart Encode	Smart Encode. <ul style="list-style-type: none"> Smart encode includes H.264 & H.265. The storage space will be reduced fifty percent when smart encode is enable. Only main stream supports smart encode. 	[Setting method] Click the button on to enable Smart Encode .

The SVC stream and ROI can be set when the Smart Encode is disabled.

5.3 Device

User can set **Local Network, Device Port, Date and Time, Camera, OSD, Microphone, System and Voice Denoise**, as shown in Figure 5-3.

Figure 5-3 Device interface

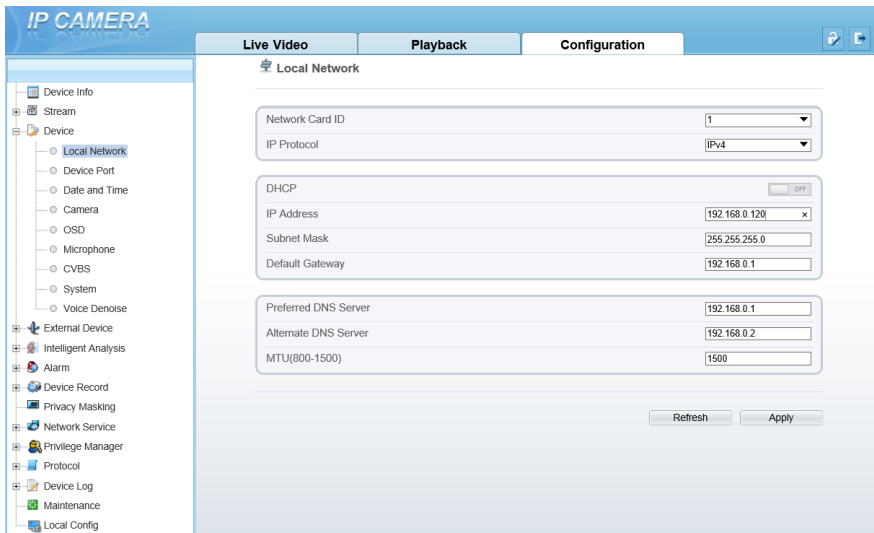

Device Port: Control port, http port and RTSP port.

Date and Time: Time zone, daylight savings time, device time, current PC time, set manually and NTP.

Camera: Channel name, video system and video refresh frequency.

OSD: Time, custom OSD (at most 8 reminders can be set), advanced settings (time format, font color, font size, font transparency, font on lighted back and device name).

Microphone: Microphone type and volume.

System: Language of OSD, Web mode.

Voice Denoise: enable or disable the function.

5.4 Intelligent Analysis

User can set **Perimeter**, **Single Virtual Fence**, **Double Virtual Fences**, **Loiter**, **Multi Loiter**, **Object Left**, **Object Removed**, **Abnormal Speed**, **Converse**, **Illegal Parking**, **Signal Bad** and **Advanced**, as shown in Figure 5-4.

Figure 5-4 Intelligent analysis interface

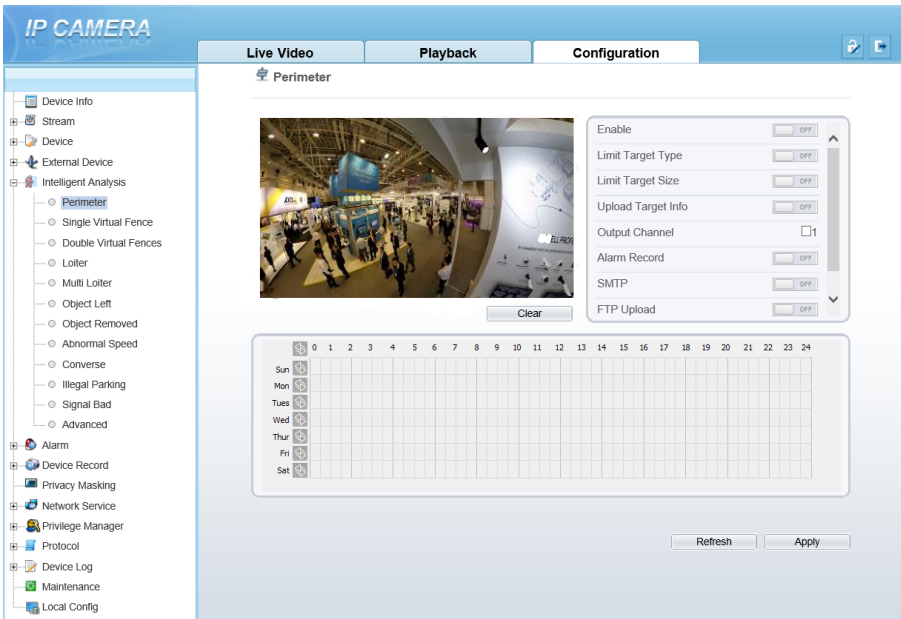

If user wants to enable intelligent analysis, he needs to enable the function and set schedule respectively.

5.5 Alarm

User can set **Alarm Output**, **Disk Alarm**, **Network Alarm**, **I/O Alarm Linkage**, **Motion Alarm**, and **Push Message**, as shown in Figure 5-5.

Figure 5-5 Alarm interface

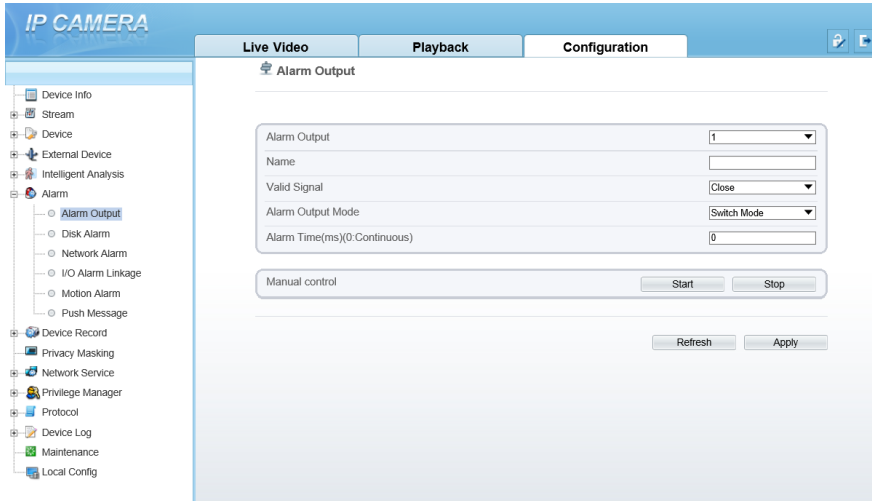

User set parameters of alarm when you need.

5.6 Device Record

User can set **Record Policy** and **Record Directory** on device record interface, as shown in Figure 5-6.

Figure 5-6 Device record interface

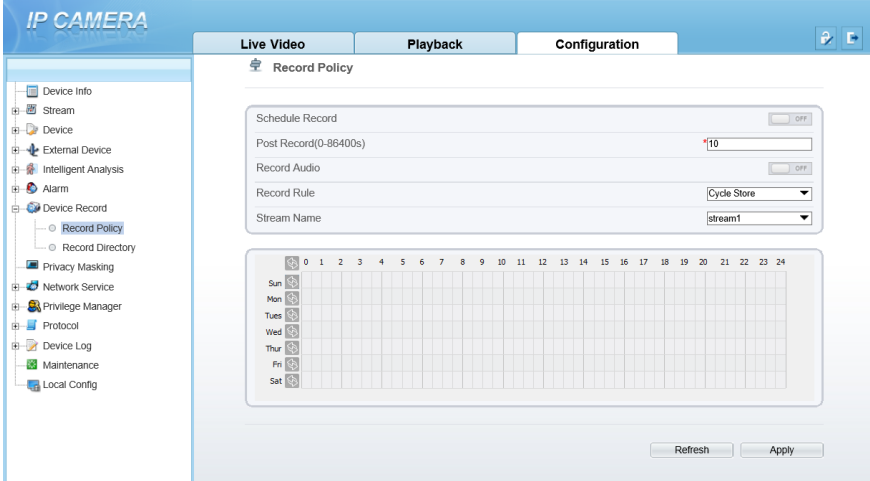

5.7 Privacy Masking

User can set at most four privacy masking areas, as shown in Figure 5-7. Dragging the mouse cursor to choose area to mask, click **Add** to save the area.

Figure 5-7 Privacy masking interface

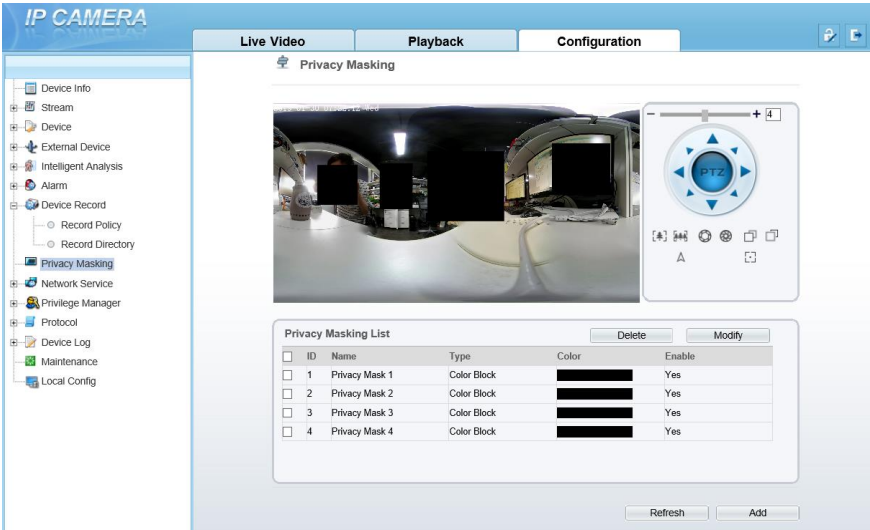

5.8 Network Service

User can set **802.1X**, **DDNS**, **PPPoE**, **Port Mapping**, **SMTP**, **FTP**, **IP Filter**, **CGI Alarm Service Center** and **SNMP** at network interface, as shown in Figure 5-8.

Figure 5-8 Network service interface

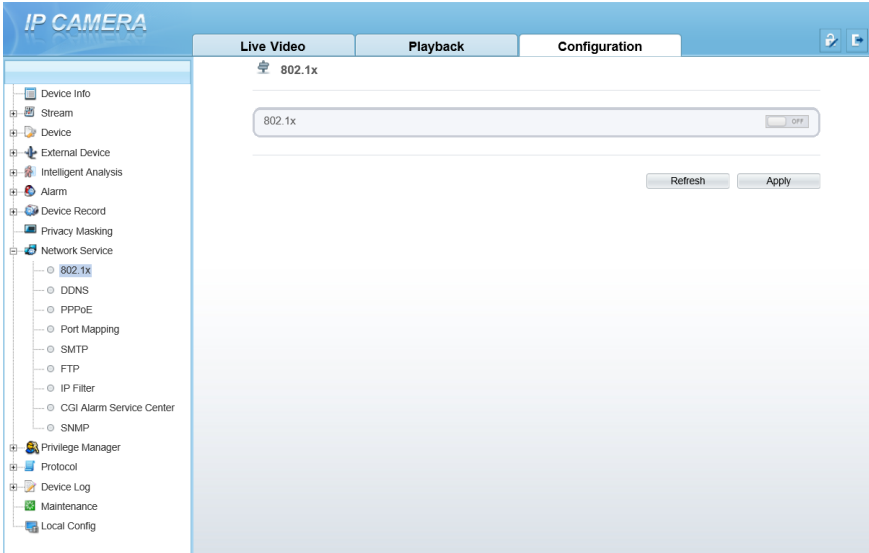

User set the network parameter according to network knowledge. Click Apply to save the settings.

5.9 Privilege Manager

User can add the new user accounts, modify or operate the authority of user, as shown in Figure 5-9.

Figure 5-9 Privilege manager interface

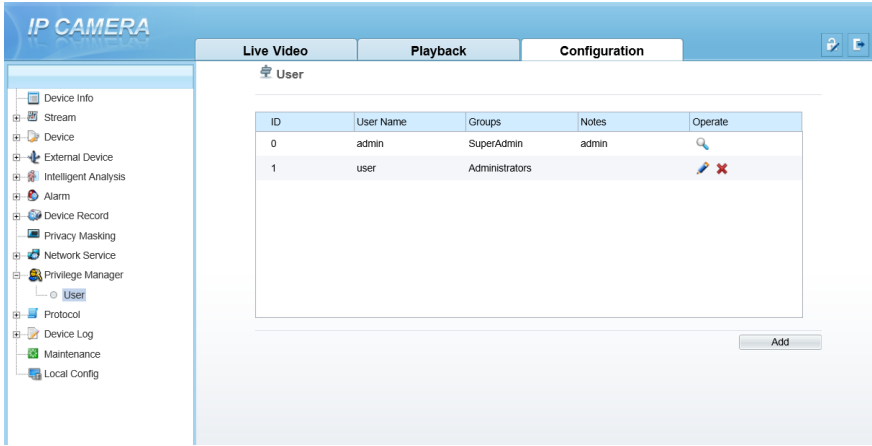

5.10 Protocol

User can set **Protocol Info**, **Security**, **CMS Configuration** and **Multicast Param**, as shown in Figure 5-10.

Figure 5-10 Protocol interface

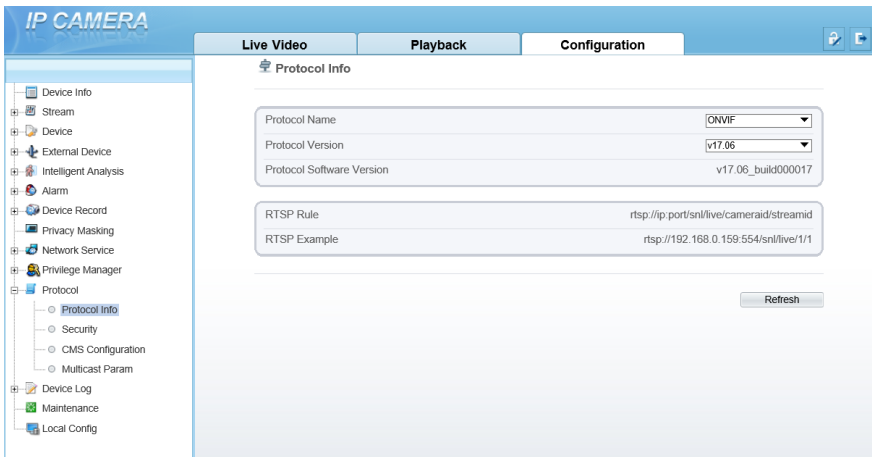

5.11 Device Log

User can view the **Operation Log** and **Alarm Log**, **Collect All Log**, as shown in Figure 5-11.

Figure 5-11 Device log interface

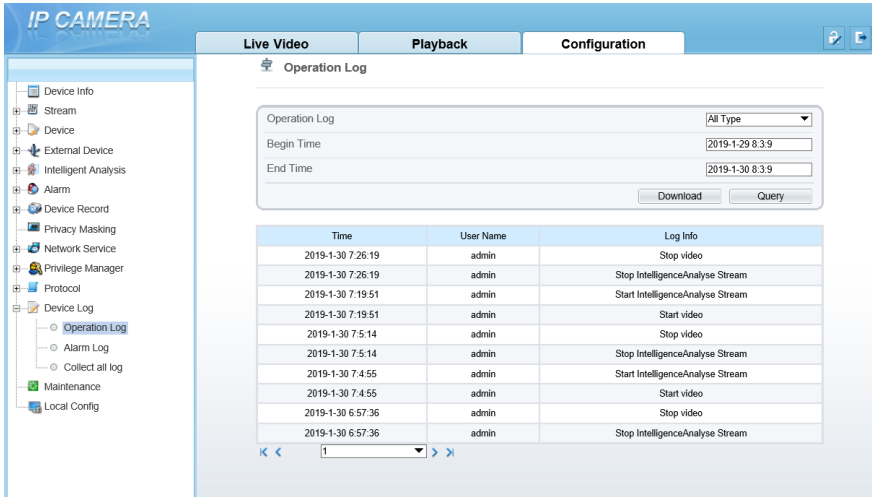

The screenshot shows the IP CAMERA web interface with the 'Device Log' section selected in the left sidebar. The 'Operation Log' tab is active, displaying a table of log entries. The table has three columns: Time, User Name, and Log Info. The entries are as follows:

Time	User Name	Log Info
2019-1-30 7:26:19	admin	Stop video
2019-1-30 7:26:19	admin	Stop IntelligenceAnalyse Stream
2019-1-30 7:19:51	admin	Start IntelligenceAnalyse Stream
2019-1-30 7:19:51	admin	Start video
2019-1-30 7:5:14	admin	Stop video
2019-1-30 7:5:14	admin	Stop IntelligenceAnalyse Stream
2019-1-30 7:4:55	admin	Start IntelligenceAnalyse Stream
2019-1-30 7:4:55	admin	Start video
2019-1-30 6:57:36	admin	Stop video
2019-1-30 6:57:36	admin	Stop IntelligenceAnalyse Stream

5.12 Maintenance

User can **Restart**, **Update** and **Restore to Factory Default**, as shown in Figure 5-12.

Figure 5-12 Maintenance interface

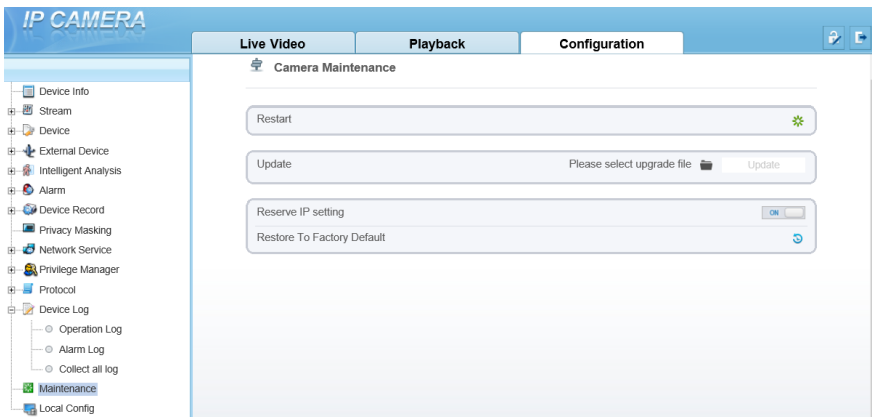

The screenshot shows the IP CAMERA web interface with the 'Maintenance' section selected in the left sidebar. The 'Camera Maintenance' tab is active, displaying several maintenance options:

- Restart**: A button with a green star icon.
- Update**: A button with a folder icon and the text 'Please select upgrade file'.
- Reserve IP setting**: A button with a 'ON' indicator.
- Restore To Factory Default**: A button with a circular arrow icon.

5.13 Local Config

User can set local configuration such as **Snapshot picture format**, **Snapshot Save Path**, **Local Record Save Path**, **Local Record File Size** and **Hardware Decode**, as shown in Figure 5-13.

Figure 5-13 Local config interface

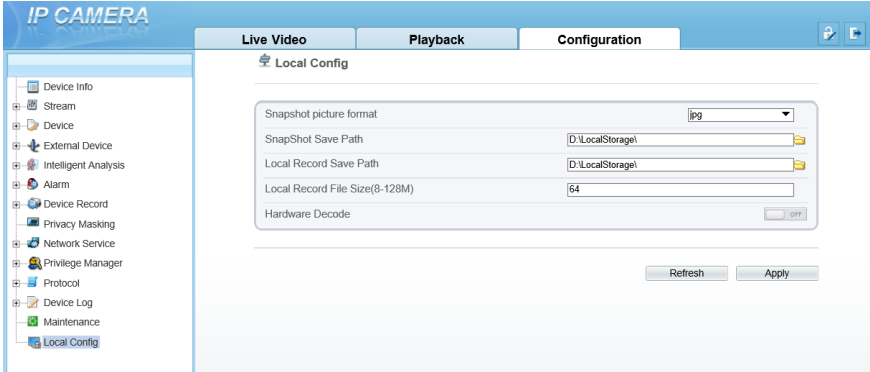

----End

6 Technical Specifications

Table 6-1 lists the specifications of the camera.

Table 6-1 Technical specifications

Type	Parameter	Description
Camera performance	Pixel	Single lens is 8 MP, four lens joint is 32 MP(8k)
	Video feature	Optional, PAL or NTSC (the default value is PAL)
	Effective pixel	7680*4320
	Field angle	V 360° * H 360°
	Digital zoom	Support
	The lowest illumination	Color: 0.002 Lux@(F 2.2, AGC ON)
	DayNight	Color
	Optical filter	Support fixed
	IR distance	N/A
	Shutter speed	1/5 s~1/20K s
	Gain control	Manual / Auto (the default value is auto)
	White balance	Manual / Auto (the default value is auto)
	Correction of lens aberration	Support
	WDR	Support digital WDR
	HLC	Support
BLC	Support	
Digital image stabilization	Support	
Lens	Prime lens	Customization ϕ 12mm fisheye lens

Type	Parameter	Description
features	Focal length of lens	2.2 mm
	F value	2.2
	F OV	190°
External interface	Network interface	RJ-45, 10/100Base-T self-adaptive Ethernet port, support POE apply, conform to 802.3 AT
	Power supply	DC12V/ PoE +
	RS485	N/A
	Fiber optic interface	N/A
	Alarm interface	One alarm input and one alarm output
	Audio interface	one audio input, one audio output
	Microphone	Double Mic
	Stereo	Support
	Two-way voice	Support
	CVBS interface	N/A
	SD card interface	Reserved
	Reset	Restore factory settings
Video features	Video encode format	H.264/ H.265/MJPEG
	Multiple code streams	4 streams (the forth is sub stream, support preview and record)
	Image setting	Brightness, contrast, saturation, sharpness
	Bit rate format	CBR/VBR
	Synchronous mode	Inter-sync
	SNR	≥ 55 dB
	DNR	Auto/manual(support for 2D and 3D noise reduction)
Audio features	Audio encoding format	Support for G711
	Audio bit rate	64kbps(G.711), 128kps (RAW_PCM)
Network features	Front-end access protocol	ONIVF, GB/T 28181,Third-part protocol

Type	Parameter	Description
	Network protocol	IPv4/ Ipv6, RTSP/RTP/RTCP, TCP/UDP, HTTPS, DHCP, DNS, DDNS, PPPoE, SMTP
	Heartbeat mechanism	Support
	Wireless network	N/A
	Streaming mode	Unicast
	Number of users in concurrent access	10
	SNMP	Support
	Automatic device discovery	Support
Function	Intelligent analysis	Support
	Preview video mode	Tile 360° ,perspective mode, crystal ball mode, planet mode, auto-rotation mode.
	Defog	Support
	ROI	Support
	Time segment	Support
	IO alarm detection	Support
	Privacy mask	Support
	Character display	Time, date, name and user-defined characters
	Security	Password protection, multi-level user group management, user-define permissions, and one-key reset
	Reliability	Provide software and hardware watchdogs and automatic fault recovery
	User authority	Two class, administrator and general users. The administrator can assign various permissions to general users
	Support SDK development	Linux C /windows C & C++ SDK

Type	Parameter	Description
Storage	Local storage type	N/A
	Capacity	N/A
	SD card availability	N/A
	Remote storage	N/A
WEB applications	Language	Support 10 languages; Chinese is default value, English, Spanish, Portuguese, Polish, Italian, Russian, French, Hungarian, Czech.
	Support browsers	Windows IE 8 or later version, Firefox, Chrome
	Manager and maintenance	Not Supported Web upgrade, separate upgrade tools
	Web interface style	Customization/standard
Other	Power supply	DC 12 V/ POE+
	Operating temperature	-40°C to +60°C
	Operating humidity	RH 90% MAX (no condensation)
	EMC level	Conform to CE/FCC and ministry of public security standard
	Protection level	IP66
	Dimensions	112.2*112.2*90 mm (without bracket)
	Weight	About 1175 g (without bracket)